

poalgi | KITCHEN

Estimados clientes:

Tienen en sus manos el nuevo catálogo de **poalgi** kitchen. Este trabajo supone el resultado de un enorme esfuerzo y dedicación realizado por y para ustedes.

Somos líderes en fabricación de fregaderos sintéticos en el mercado español y estamos con usted desde hace más de 25 años. Nuestro aval es la fidelidad de nuestros clientes y la presencia de nuestra marca en más de 30 países. **poalgi** le invita a conocer un nuevo concepto de cocina actual, fresca, sofisticada, vanguardista y funcional. Las colecciones de **poalgi** conjugan los diseños más innovadores con materiales inteligentes que alargan la vida de nuestros productos y nos permiten crear modelos exclusivos con una gran variedad cromática.



poalgi | KITCHEN

Dear customer

You have in your hands the new catalog of **poalgi** kitchen. This work is the result of an enormous effort and dedication made by and for you.

poalgi, with more than 25 years of experience in the sector, has become leaders in synthetic sink manufacturing in the Spanish market. Our consignment is our clients' fidelity and the presence of our brand in more than 30 countries.

poalgi invites you to know a new concept of kitchen: actual, fresh, sophisticated, avant-garde and functional. The **poalgi** collections combine the most innovative designs with intelligent materials that stretch on our products lives and allow us to create exclusive models with a great chromatic variety.

Cher client:

Vous avez entre vos mains le nouveau catalogue de **poalgi** kitchen. Ce travail représente le résultat d'un énorme effort et engagement pris par et pour vous.

Leader dans la fabrication des éviers synthétiques sur le marché espagnol, **poalgi** marque le monde de la cuisine de son empreinte depuis plus de 25 ans. La fidélité de nos clients et notre présence dans plus de 30 pays constitue pour nous les preuves les plus objectives de la qualité de notre travail. **poalgi** vous invite à découvrir un nouveau concept de cuisine: frais, sophistiqué, moderne et fonctionnel.

Les collections **poalgi** allient design innovant et matériaux intelligents qui prolongent la vie de nos produits et nous permettent de créer des modèles uniques avec une grande variété de couleurs.

poalgi | I+D+i

poalgi desarrolla materiales inteligentes, con una gran diversidad de acabados, que nos sitúan como una de las firmas alternativas al mercado del mármol y el acero inoxidable. El resultado es un producto resistente, adaptable y versátil avalado por el certificado de calidad AENOR.

poalgi develops intelligent materials, with a great variety of final products, which situate us as one of the firm alternatives of the marble and stainless steel market. The result is a tough adaptable and versatile product endorsed by the AENOR quality certificate.

poalgi développe des matériaux intelligents avec une grande variété de finitions, lesquels nous permettent d'offrir une alternative aux produits en granit, en acier inoxydable... Le résultat est un produit robuste, adaptable et polyvalent approuvée par le certificat de qualité AENOR.





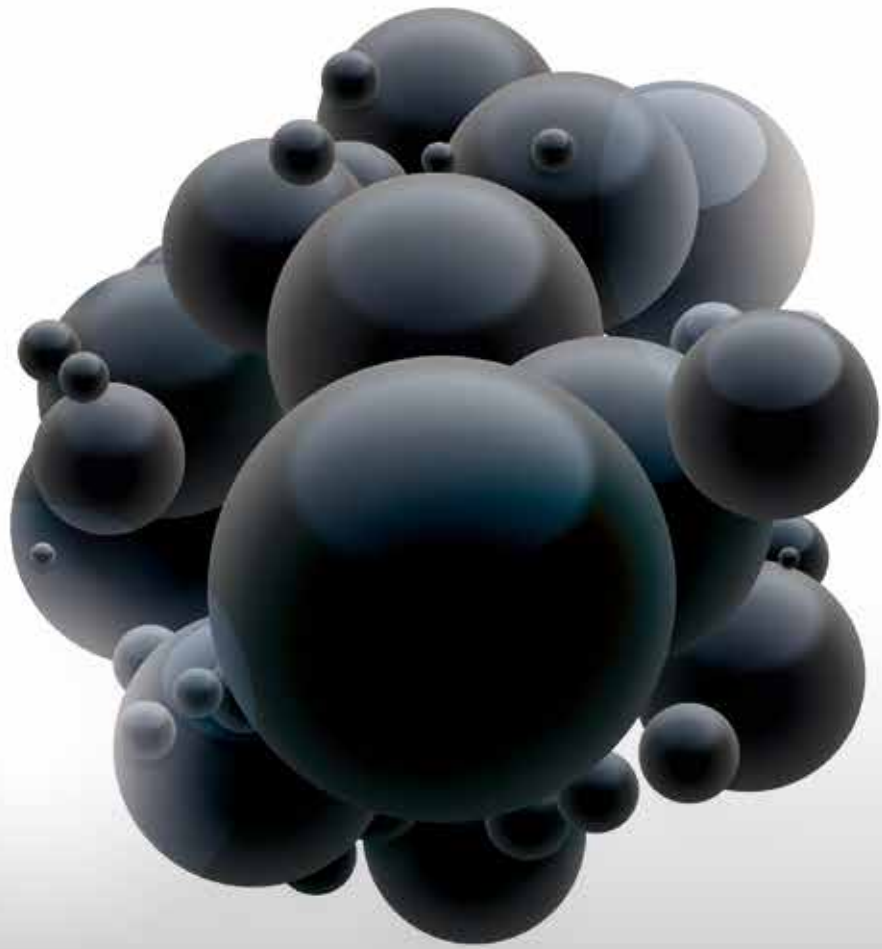

poalgi | MATERIALS

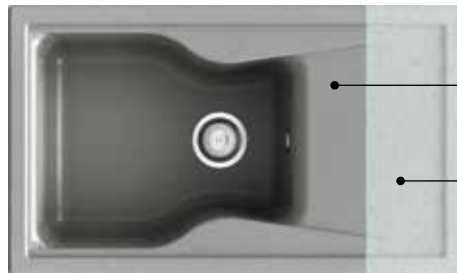

Gel_Coat de altas prestaciones
Gel_Coat layer high performance
Gel_Coat couche haute performance

Partículas de alúmina con resina técnica
Particles of alumina with technical resin
Des particules d'alumine avec une technique de
résine

Roc_Stone® es un material compuesto de cargas minerales aglutinadas con resinas técnicas de alta resistencia. Esta mezcla surge de un proceso de investigación certificado por **AENOR**. El componente principal del **Roc_Stone®** es la partícula de alúmina. Empleamos tres granulometrías diferentes de alúmina para conseguir una masa compacta y homogénea.

La resina técnica añadida, envuelve cada partícula de alúmina formando un material altamente compactado. La superficie de nuestros fregaderos está formulada por un **Gel_Coat** de altas resistencia y prestaciones.

El tratamiento en superficie de nuestros productos no deja lugar a la aparición de posibles bacterias.

Roc_Stone® garantiza la resistencia bajo carga, el daño de impacto y los efectos de las altas y bajas temperaturas, además de la seguridad del transporte, la instalación y el uso diario. Gracias al tratamiento V (de antienviejecimiento), la superficie del fregadero se mantiene en perfectas condiciones durante toda su vida útil.

poalgi | MATERIALS

Roc_Stone® is a composite made of mineral fillers bonded with high strength resins. We developed this mix as a result of a research process certified by **AENOR**.

The main component of **Roc_Stone®** is the alumina particle. We use three varying granulometries of alumina to obtain a compact and homogeneous mass. The added technical resin wraps each alumina particle forming a highly compacted material. The surface of our sinks is composed by a **Gel_Coat** of high resistance and performance.

Roc_Stone® guarantees load resistance, impact damage and the effects of high and low temperatures, as well as security during transportation, installation and daily use. All our products maintain their original appearance and conditions for years thanks to the anti-aging treatment performed by **poalgi**.

Roc_Stone® est un composite à base de charges minérales liées à des résines à haute résistance.

Ce mélange émerge d'un processus de recherche certifié par **AENOR**.

Le composant principal du **Roc_Stone®** est la particule d'alumine. Nous utilisons trois granulométries différentes d'alumine pour obtenir une masse compacte et homogène. La résine technique ajoutée entoure chaque particule d'alumine formant un matériau fortement compacté.

La surface de nos éviers est composée d'un **Gel_Coat** de haute résistance et performance.

Roc_Stone® garantit la résistance à la charge, les dommages d'un impact et les effets des hautes et basses températures, ainsi que la sécurité pendant le transport, l'installation et l'utilisation quotidienne. Grâce à un traitement anti-vieillessement, chez **poalgi**, nous obtenons que nos produits conservent leur apparence et état pendant des années.



10	ZIE
24	GANDIA
38	SHIRA
56	COLOR PLUS
60	CITY
74	KUMA

ZIE

_ NUEVO ACABADO SOFT **_** NEW SOFT FINISH **_** NOUVELLE FINITION SOFT

poalgi ha creado la colección Zie para cumplir con un gran desafío: un nuevo concepto de cocina, adaptada al siglo XXI. Los diseños minimalistas, de líneas cuadradas, depuradas y aparente simplicidad convierten a Zie en una colección que busca sofisticación y modernidad. La versatilidad de nuestros modelos pone en su mano una infinidad de acabados y composiciones.



ZIE_81 Ref. 185. Color**standard**_CT Concret
Finish_Soft





ZIE_81

Nuevo acabado soft.
New soft Finish.
Nouvelle finition soft.



ZIE_81 1C + Esc. Ref. 185. Color**standard**_CT Concret
Finish_Soft

poalgi has created Zie collection to achieve a goal: a new kitchen concept, adapted to the XXIst century. The minimalist details, square lines, depurated and apparent simplicity make Zie a collection that looks for sophistication and modernity. The versatility of our models put in your hand an infinity of touches and compositions.



Cesta escurreplatos_Dish drainer_Égouttoir à vaiselle.
Mod. Zie Ref_ACC17

ZIE_60

Nuevo acabado soft.
New soft Finish.
Nouvelle finition soft.



ZIE_60 Ref. 182. Color**standard**_NL Negro liso
Finish_soft

poalgi a conçu la collection Zie dans l'idée de relever un défi: imaginer un nouveau concept de cuisine, adapté au XXIème siècle. Un dessin minimaliste, des arêtes marquées, une ligne épurée et d'apparente simplicité : la collection Zie se caractérise par sa sophistication et sa modernité. La polyvalence de nos modèles rendent possible une multitude de finitions et de compositions.





COMPAC
THE SURFACES COMPANY

Darkconcrete

NL Negro liso soft



Dosificador de jabón_Soap dispenser_Distributeur de savon.
Ref. A888/C



ZIE_70



ZIE_70_1^{1/2}C Ref. 173. Colorplus_Ral_8015
Finish_Gloss

El sistema Color**plus** de **poalgi**, le permite personalizar el color de su fregadero y combinarlo con los múltiples acabados y materiales presentes en las últimas tendencias en el diseño del espacio cocina.

The Color**plus** system of **poalgi** gives you the possibility to customize the colour of your sink and to combine it with the multiple finishes and materials present in the latest trend in the design of kitchen sector.

Le système Color**plus** de **poalgi** permet de personnaliser la couleur de son évier et de le combiner avec les multiples finitions et matériaux présents dans les dernières tendances dans la conception de l'espace cuisine.

ZIE_70 2C



ZIE_70_2C Ref. 174. Color **standard**_ BL_Blanco.
Finish_Gloss



ZIE_45 Ref. 171 Gloss / Ref. 181 Soft.



Profundidad cubeta 200 mm.
Bucket depth 200 mm.
Profondeur du godet 200 mm.

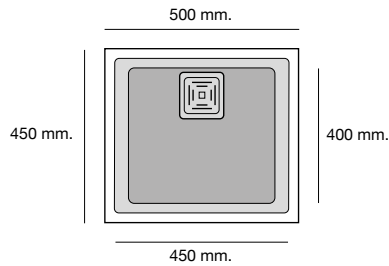

Roc_Stone®
Antibacteriano
Bajo encimera
Antibacterial
Undermount
Antibactérien
Sous plan

ZIE_60 Ref. 172 Gloss / Ref. 182 Soft



Profundidad cubeta 200 mm.
Bucket depth 200 mm.
Profondeur du godet 200 mm.

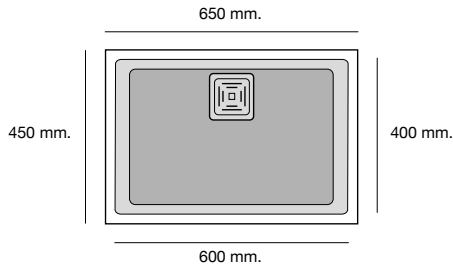

Roc_Stone®
Antibacteriano
Bajo encimera
Antibacterial
Undermount
Antibactérien
Sous plan

ZIE_70 1 1/2 C. Ref. 173 Gloss / Ref. 183 Soft.



Profundidad cubeta 200 mm. y 150 mm.
Bucket depth 200 mm. and 150 mm.
Profondeur du godet 200 mm. et 150 mm.

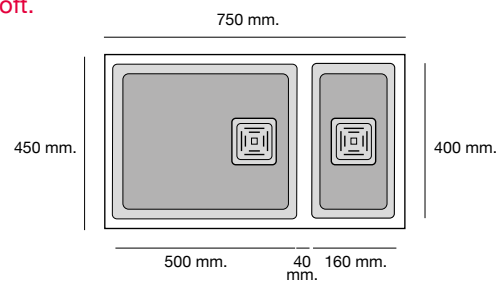

Roc_Stone®
Antibacteriano
Bajo encimera
Colocación reversible
Antibacterial
Undermount
Reversible placement.
Antibactérien
Sous plan
Installation réversible

ZIE_70 2C Ref. 174 Gloss / Ref. 184 Soft.



Profundidad cubeta 200 mm.
Bucket depth 200 mm.
Profondeur du godet 200 mm.

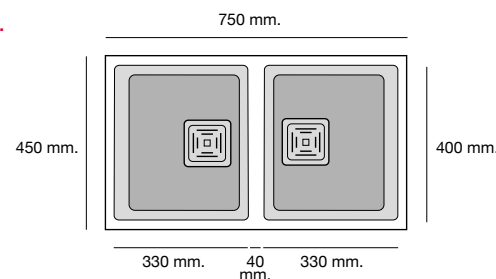

Roc_Stone®
Antibacteriano
Bajo encimera
Antibacterial
Undermount
Antibactérien
Sous plan

La colección ZIE incluye válvulas cuadradas, sifón, sellante y hoja de montaje. Barra de anclaje bajo encimera incluida.
 The ZIE collection includes square valves, siphon, sealant and mounting sheet. Under anchor bar included.
 La collection ZIE inclut une vanne carré, un siphon, du silicone d'étanchéité et la feuille de montage. Barre d'ancrage pour sous plan inclus.

ZIE_81 1C + Esc. Ref. 175 Gloss / Ref. 185 Soft

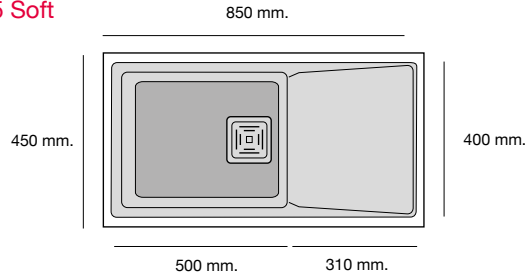

Profundidad cubeta 200 mm.
 Bucket depth 200 mm.
 Profondeur du godet 200 mm.

Roc Stone®
 Antibacteriano
 Bajo encimera
 Colocación reversible
 Antibacterial
 Undermount
 Reversible placement.
 Antibactérien
 Sous plan
 Installation réversible

Accesorios_ accessories_accessoires

Cesta escurrplatos_Dish drainer_Égouttoir à vaisselle.
 MOD. ZIE Ref. ACC17. 340 mm. x 340 mm.



Acero inoxidable
 stainless steel
 acier inoxydable

Dosificador de jabón_Soap dispenser_Distributeur de savon.
 Ref. A888/C



Latón Cromado
 Chrome plated brass
 laiton chromé

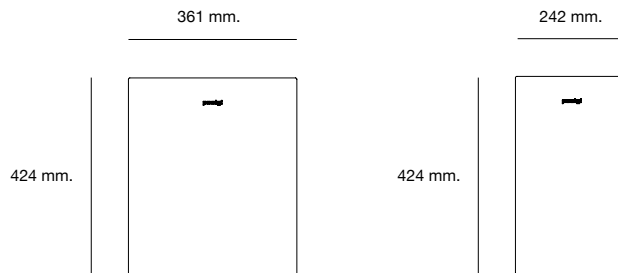

Ref. TCZ1

Ref. TCZ2

Nuevas tablas de corte de polímero técnico.
 New technical polymer cutting tables
 Nouvelles planches à découper en polymère technique.
 Ref. TCZ.

Respetar las medidas de colocación bajo encimera, según esquema de corte indicado en tarifa.
 You should follow the under anchor purchase placement measures, according the cutting template indicated in pricelist document.
 Vous devez respecter les mesures d'installation sous plan, selon le modèle de coupe indiqué dans le document tarif.

GANDIA

La nueva estética de la cocina. Es la síntesis de los espacios diseñados con líneas integradas, limpias y funcionales. La colección Gandia es la primera de nuestras series por su gran capacidad para aportar a la cocina los diseños más atrevidos. Sus modelos han logrado convertir las encimeras en superficies lisas, de líneas puras dotando un gran orden de continuidad, creando tendencia.





GANDIA_50 + GANDIA_Escurreidor Ref. 164 + Ref. 166.
Color **standard**_AL_Albero



GANDIA_164+166



GANDIA_50 + GANDIA_Escurridor Ref. 164 + Ref. 166.
Color **standard**_AL_Albero.

A new kitchen esthetic. It is the synthesis of spaces designed with integrated, clean and functional lines. The Gandia Collection is the number one of our series for it's great capacity to supply the kitchen with the most daring designs. Its models transform countertops into smooth surfaces, with pure lines, giving them continuity and creating trends.





GANDIA_165



GANDIA_70 Ref. 165. Color**standard**_NL_Negro liso

Esthétisme et fonctionnalité. La collection Gandia est la meilleure alliée des espaces conçus avec des lignes intégrées, simples et fonctionnelles. Par ses multiples combinaisons possibles, elle constitue un atout important pour les conceptions de cuisine, même les plus audacieuses. Grâce à cette collection, valorisez également votre plan de travail, en gardant continuité et pureté des lignes.





COMPAC
THE SURFACES COMPANY

Portoro

NL Negro liso

GANDIA_161 + 164



GANDIA_15 Ref. 161 + GANDIA_50 Ref. 164
Color **standard**_PG_Pergamón



COMPAC

THE SURFACE COMPANY

Blackama

PG_Pergamón



GANDIA_163



GANDIA_40 Ref.163. Colorstandard_PG_Pergamón

GANDÍA_15 Ref. 161



Profundidad cubeta 150 mm.
Bucket depth 150 mm.
Profondeur du godet 150 mm.

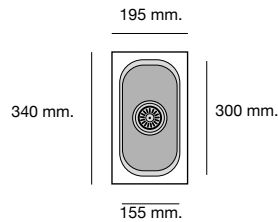

Roc_Stone®
Antibacteriano
Sobre encimera
Bajo encimera
Antibacterial
Inset
Undermount
Antibactérien
À encastrer
Sous plant

GANDÍA_35 Ref. 162



Profundidad cubeta 200 mm.
Bucket depth 200 mm.
Profondeur du godet 200 mm.

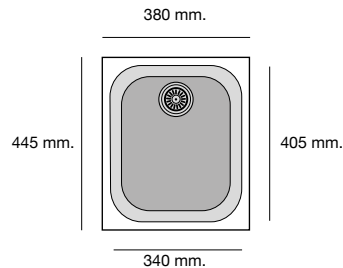

Roc_Stone®
Antibacteriano
Sobre encimera
Bajo encimera
Antibacterial
Inset
Undermount
Antibactérien
À encastrer
Sous plant

GANDÍA_40 Ref. 163



Profundidad cubeta 200 mm.
Bucket depth 200 mm.
Profondeur du godet 200 mm.

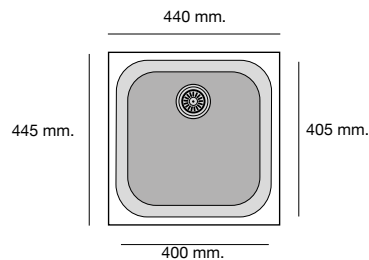

Roc_Stone®
Antibacteriano
Sobre encimera
Bajo encimera
Antibacterial
Inset
Undermount
Antibactérien
À encastrer
Sous plant

GANDÍA_50 Ref. 164



Profundidad cubeta 200 mm.
Bucket depth 200 mm.
Profondeur du godet 200 mm.

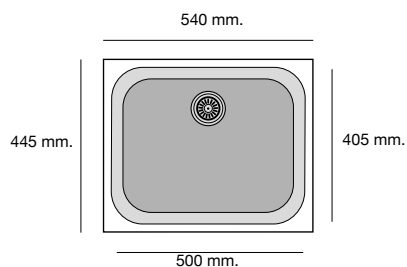

Roc_Stone®
Antibacteriano
Sobre encimera
Bajo encimera
Antibacterial
Inset
Undermount
Antibactérien
À encastrer
Sous plant

Cada composición de la serie GANDIA incluye válvulas, sifón, sellante y plantilla de encastre. Barra de anclaje incluida.
 Each composition of the GANDIA series includes valves, siphon, sealant and template inlay. Anchor bar included.
 Chaque modèle de la série GANDIA comprend une vanne, un siphon, du silicone d'étanchéité et de le gabarit d'encastrement. Barre d'ancrage inclus.

GANDÍA_70 Ref. 165



Profundidad cubeta 200 mm.
 Bucket depth 200 mm.
 Profondeur du godet 200 mm.

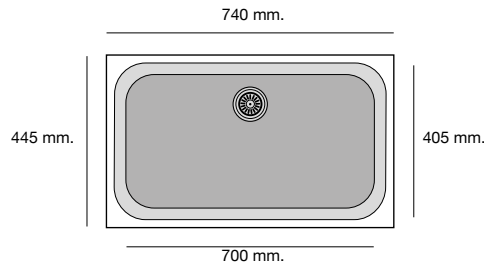

Roc Stone®
 Antibacteriano
 Sobre encimera
 Bajo encimera
 Antibacterial
 Inset
 Undermount
 Antibactérien
 À encastrer
 Sous plant

GANDÍA_ESCURRIDOR Ref. 166



Profundidad cubeta 20 mm.
 Bucket depth 20 mm.
 Profondeur du godet 20 mm.

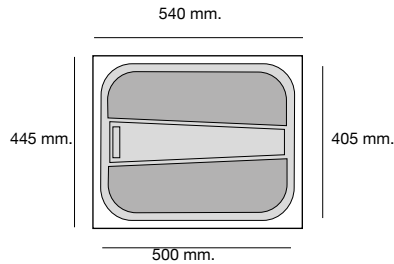

Roc Stone®
 Antibacteriano
 Sobre encimera
 Bajo encimera
 Antibacterial
 Inset
 Undermount
 Antibactérien
 À encastrer
 Sous plant

Accesorios_ accessories_ accessoires

Cesta escurreplatos_Dish drainer_Égouttoir à vaisselle.
 Acero inoxidable_stainless steel_acier inoxydable
 MOD. GANDIA Ref. ACC16 340 mm. x 340 mm.



Válvula oculta_Concealed valve_Vanne occulte
 Opcional_optional_en option. Ref_670_Mer_SM



Acero Inoxidable
 stainless steel
 acier inoxydable

Dosificador de jabón_Soap dispenser_Distributeur de savon.
 Ref. A888/C



Latón Cromado
 Chrome plated brass
 laiton chromé

SHIRA

SHIRA Ref. 505 Colorstandard_TU_Tundra



La cocina tiene vida, **poalgi** te ayuda a disfrutarla. La colección Shira logra una estética rompedora y una vitalidad cromática que traslada la cocina a una nueva dimensión. Los materiales sofisticados y armónicos convierten a la colección Shira en sinónimo de funcionalidad, frescura, espacios vivos y desenfadados.



SHIRA_505



SHIRA Ref. 505 Colorstandard_TU_Tundra

The kitchen is alive, **poalgi** helps you enjoy it. The Shira Collection achieves a surprising esthetic and a chromatic vitality that moves the kitchen to a new dimension. The harmonic and sophisticated materials make the Shira collection a synonym of functionality, freshness, live and carefree spaces.



COMPAC
THE SURFACES COMPANY

Unique Calacatta

TU_Tundra



SHIRA_503



SHIRA Ref. 503 Colorstandard_BR_Brown.

La cuisine est un lieu de vie et de partage; **poalgi** vous aide à en profiter pleinement. Le dessin affirmé de la collection Shira, associé à une couleur originale, projetera votre cuisine dans une nouvelle dimension esthétique. Les matériaux sophistiqués et harmonieux de cette collection font des évier Shira un hymne à la fonctionnalité et à la fraîcheur stylistique.



COMPAC
THE SURFACES COMPANY

BR_Brown

Blackama



Textura_texture detail_ détail de texture.

SHIRA_501



SHIRA Ref. 501. Color **standard**_AL_Albero





SHIRA_502



SHIRA Ref. 502 _Colorplus_Ral_7043

El sistema **Colorplus** de **poalgi**, le permite personalizar el color de su fregadero y combinarlo con los múltiples acabados y materiales presentes en las últimas tendencias en el diseño del espacio cocina.

The **Colorplus** system of **poalgi** gives you the possibility to customize the colour of your sink and to combine it with the multiple finishes and materials present in the latest trend in the design of kitchen sector.

Le système **Colorplus** de **poalgi** permet de personnaliser la couleur de son évier et de le combiner avec les multiples finitions et matériaux présents dans les dernières tendances dans la conception de l'espace cuisine.

SHIRA_504



SHIRA Ref. 504 Color**standard**_BL_Bianco





SHIRA_507



SHIRA Ref. 507 Color **standard**_NL_Negro Liso.

SHIRA_ Información técnica_ Technical information_ Information technique

SHIRA_Ref. 501



Profundidad cubeta 220 mm.
Bucket depth 220 mm.
Profondeur du godet 220 mm.

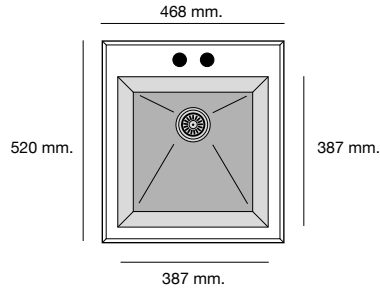

Roc_Stone®
Antibacteriano
Sobre encimera
Bajo encimera
Antibacterial
Inset
Undermount
Antibactérien
À encastrer
Sous plant

SHIRA_Ref. 502



Profundidad cubeta 220 mm.
Bucket depth 220 mm.
Profondeur du godet 220 mm.

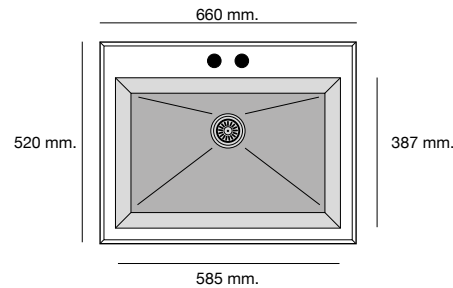

Roc_Stone®
Antibacteriano
Sobre encimera
Bajo encimera
Antibacterial
Inset
Undermount
Antibactérien
À encastrer
Sous plant

SHIRA_Ref. 503 D. (Escurridor derecha)
SHIRA_Ref. 503 I. (Escurridor izquierda)



Profundidad cubeta 220 mm.
Bucket depth 220 mm.
Profondeur du godet 220 mm.

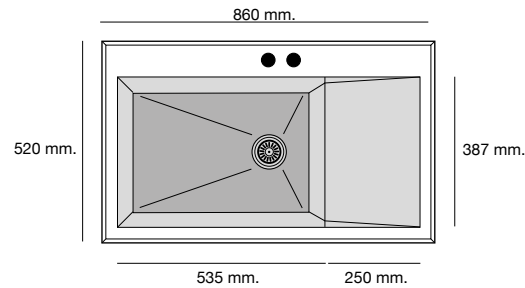

Roc_Stone®
Antibacteriano
Sobre encimera
Bajo encimera
Antibacterial
Inset
Undermount
Antibactérien
À encastrer
Sous plant

SHIRA_Ref. 504



Profundidad cubeta 220 mm.
Bucket depth 220 mm.
Profondeur du godet 220 mm.

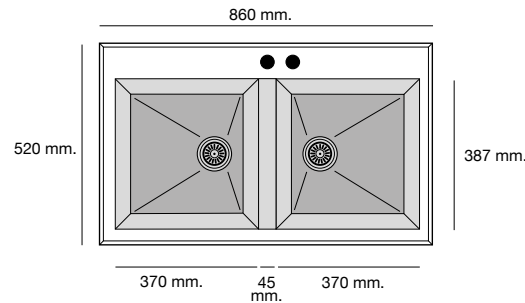

Roc_Stone®
Antibacteriano
Sobre encimera
Bajo encimera
Antibacterial
Inset
Undermount
Antibactérien
À encastrer
Sous plant

SHIRA_Ref. 505



Profundidad cubeta 220 mm.
Bucket depth 220 mm.
Profondeur du godet 220 mm.

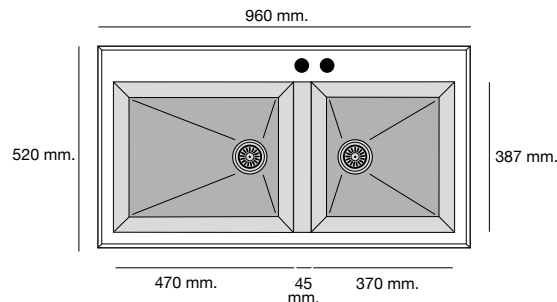

Roc_Stone®
Antibacteriano
Sobre encimera
Bajo encimera
Antibacterial
Inset
Undermount
Antibactérien
À encastrer
Sous plant

La colección SHIRA incluye válvulas automáticas extraplanas con maneta cuadrada, sifón y sellante. Barra anclaje bajo encimera opcional, sin incremento.
 The SHIRA collection includes extra-wide automatic valves with square handle, siphon and sealant. Optional under-counter anchor bar, without increment.
 La collection SHIRA inclut une vanne automatique, un siphon et du silicone d'étanchéité. Barre d'ancrage pour sous plan en option, sans supplément.

SHIRA_Ref. 506



Profundidad cubeta 220 mm.
 Bucket depth 220 mm.
 Profondeur du godet 20 mm.

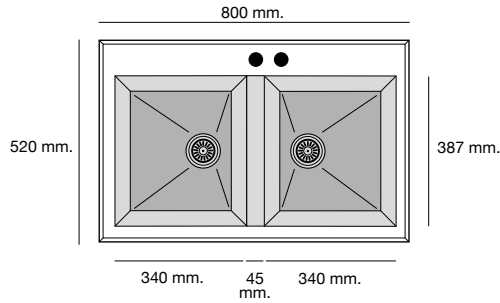

Roc_Stone®
 Antibacteriano
 Sobre encimera
 Bajo encimera
 Antibacterial
 Inset
 Undermount
 Antibactérien
 À encaster
 Sous plant

SHIRA_Ref. 507 D. (Escurridor derecha)
 SHIRA_Ref. 507 I. (Escurridor izquierda)



Profundidad cubeta 200 mm.
 Bucket depth 200 mm.
 Profondeur du godet 200 mm.

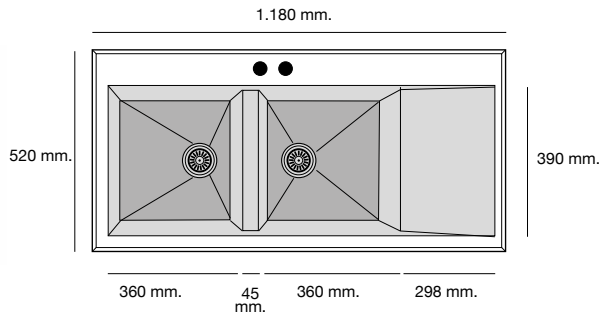

Roc_Stone®
 Antibacteriano
 Sobre encimera
 Antibacterial
 Inset
 Antibactérien
 À encaster

Accesorios_accessories_accessoires

Cesta escurreplatos_Dish drainer_Égouttoir à vaisselle.
 MOD. ZIE Ref. ACC17 340 mm. x 340 mm.



Acero inoxidable
 stainless steel
 acier inoxydable

Válvula oculta_Concealed valve_Vanne occulte
 Opcional_optional_en option.



Acero inoxidable
 stainless steel
 acier inoxydable

Dosificador de jabón_Soap dispenser_Distributeur de savon.
 Ref. A888/C



Latón Cromado
 Chrome plated brass
 laiton chromé

Sencilla_Simple_Simple Ref_670_MER_SM
 Doble_Double_Double Ref_675_MER_SM

Al incorporar la válvula oculta, eliminamos la automática.
 Es imprescindible indicar en pedido dicho cambio.
 When incorporating the hidden valve, we eliminate the automatic valve.
 En incorporant la vanne cachée, remove automatique.
 Il est essentiel pour indiquer le changement.

COLORPLUS

Las nuevas tendencias en el diseño de cocinas y sus altas posibilidades de personalización, hacen necesario una respuesta estética para poder combinar los múltiples acabados y materiales. Esta respuesta **poalgi** la da a través del sistema **Colorplus**.

Con **Colorplus poalgi**, consigues adaptar el color de tu fregadero a partir del color de cualquier superficie (encimeras sintéticas, encimeras de madera, cerámica, porcelánicos, compactos) y/o gama de color tipo carta universal **RAL** o **NCS**.



CITY Ref. 321 Color**plus**_NCS_S7010 B70G
Finish_Gloss



SHIRA Ref. 505 Color**plus**_NCS_S 6030 R10B
Finish_Gloss



New trends in kitchen design and its great personalization possibilities, make an aesthetic response necessary to be able to combine the multiple finishes and materials. **poalgi** gives that answer through the system **Colorplus**.

With **Colorplus** system, **poalgi** get fit the color of your sink, from the color of any surface (Synthetic countertop, wooden countertop, ceramic, porcelain, compact) and also, the color range as the universal system color RAL or NCS.

Les nouvelles tendances dans la conception des cuisines et ses grandes possibilités de personnalisation rendent nécessaire une réponse esthétique pour pouvoir combiner les multiples finitions et matériaux. Cette réponse, **poalgi** la donne à travers son système **Colorplus**. Avec **Colorplus**, **poalgi** réussit à adapter la couleur de votre évier à partir de la couleur de tout plan de travail (synthétiques, bois, céramiques, compactes) et/ou la gamme de couleur de type carte universel RAL ou NCS.



CITY

— NUEVA COLECCIÓN _NEW COLLECTION_ NOUVELLE COLLECTION

No renuncie al mejor diseño con los precios más competitivos. City es la más camaleónica de las colecciones de poalgi. Sus líneas curvas añaden una elegante simplicidad a cada composición.

poalgi le ofrece ininidad de acabados, que aportan a nuestra colección un estilo adaptable a todo tipo de cocinas y estilos, siempre bajo la premisa de aportar calidad con el mejor coste.



CITY Ref. 323 Colorstandard_CT_concret. Finish_Gloss



CITY_323



CITY Ref. 323 Color**standard**_CT_concret
Finish_Gloss

Do not renounce to design with the most competitive prices. Basic is the most chameleon-like of the poalgi collections. Its curved lines add an elegant simplicity to every composition.

poalgi offers an infinity of finishing touches, providing our collection with an adapting style to every kitchen and style, always aiming to provide quality with the best price.



Nuevas tablas de corte de polímero técnico_New technical polymer cutting boards _De nouvelles planches à découper en plastique ingénierie.
Ref. TCC1



CITY_332

Nuevo acabado soft.
New soft finish.
Nouvelle finition soft.



CITY Ref. 332. Color**standard**_AL_ Albero
Finish_Soft

Simplicité et fonctionnalité. Basic constitue la gamme de produit la plus large des éviers poalgi offrant une réponse à toute configuration et implantation de cuisine. Ses lignes courbes ajoutent une élégante simplicité à chaque composition.

poalgi propose de nombreuses finitions apportant adaptabilité et polyvalence quel que soit le style choisi. Un produit simple... et toujours de grande qualité.



Nuevas tablas de corte de polímero técnico_ New technical
polymer cutting boards _De nouvelles planches à découper en
plastique ingénierie.
Ref. TCC2



AL_Albero

Brownama

COMPAC
THE SURFACES COMPANY

CITY_330

Nuevo acabado soft.
New soft finish.
Nouvelle finition soft.



CITY Ref. 330 Color**standard**_TU_ Tundra
Finish_Soft





CITY_321



CITY Ref. 321 Color**standard**_CT Concret
Finish_Gloss

CITY_ Información técnica_Technical information_Information technique

CITY_Ref. 320 Gloss / Ref. 330 Soft



Profundidad cubeta 220 mm.
Bucket depth 220 mm.
Profondeur du godet 220 mm.

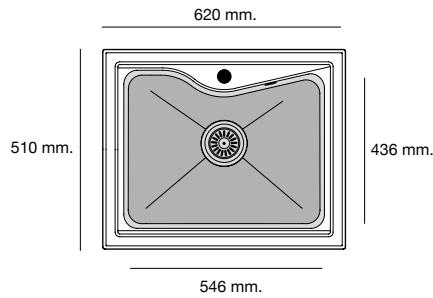

Roc_Stone®
Antibacteriano
Sobre encimera
Antibacterial
Inset
Antibactérien
À encastrer

CITY_Ref. 321 Gloss / Ref. 331 Soft



Profundidad cubeta 220 mm.
Bucket depth 220 mm.
Profondeur du godet 220 mm.

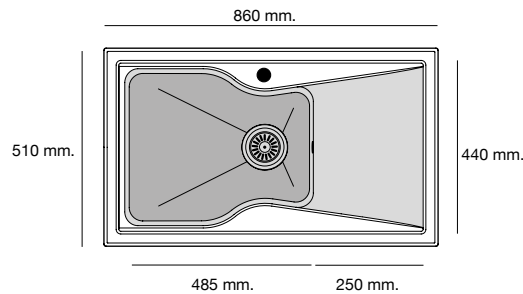

Roc_Stone®
Antibacteriano
Sobre encimera
Colocación reversible
Antibacterial
Inset
Reversible placement.
Antibactérien
À encastre
Installation réversible

CITY_Ref. 322 Gloss / Ref. 332 Soft



Profundidad cubeta 220 mm.
Bucket depth 220 mm.
Profondeur du godet 220 mm.

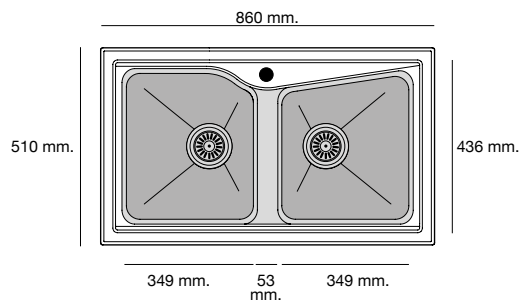

Roc_Stone®
Antibacteriano
Sobre encimera
Antibacterial
Inset
Antibactérien
À encastrer

CITY_Ref. 323 Gloss / Ref. 333 Soft



Profundidad cubeta 220 mm.
Bucket depth 220 mm.
Profondeur du godet 220 mm.

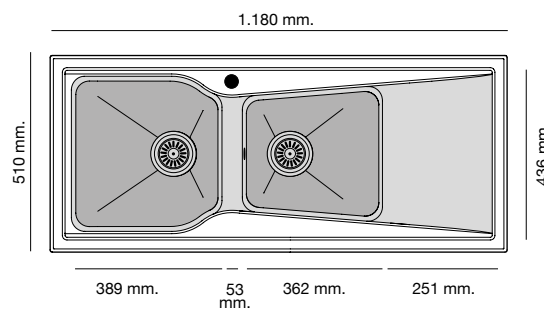

Roc_Stone®
Antibacteriano
Sobre encimera
Colocación reversible
Antibacterial
Inset
Reversible placement.
Antibactérien
À encastre
Installation réversible

La colección CITY incluye garras de anclaje y válvulas.
 The CITY collection includes anchor and valves.
 La collection CITY comprend la barre de soutien et des vannes

Accesorios_ accessories_ accessoires

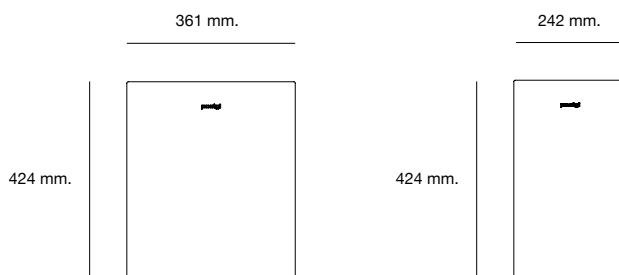

Nuevas tablas de corte de polímero técnico.
 New technical polymer cutting tables
 Nouvelles planches à découper en polymère technique.

Ref. TCC1
 Compatible con Ref. 321,331, 322,
 332, 323, 333
 Compatible with Ref. 321,331, 322,
 332, 323, 333
 Compatible avec Ref. 321,331, 322,
 332, 323, 333

Ref. TCC2
 Compatible con todos los modelos de la
 colección CITY.
 Compatible with all models in the CITY
 collection.
 Compatible avec tous les modèles de la
 collection CITY.



Acero inoxidable
 stainless steel
 acier inoxydable

Válvula oculta_Concealed valve_Vanne occulte
Opcional_optional_en option.
Sencilla_Simple_Simple Ref_670_MER_SM
Doble_Double_Double Ref_675_MER_SM

KUMA

La estética industrial y urbana adquiere todo el sentido gracias a Kuma. Este modelo de cocina emerge como una de las tendencias más utilizadas para las viviendas modernas y de estilo vanguardista. El diseño depurado y los aires minimalistas que se respiran en las grandes urbes son las bases que inspiran la colección Kuma.



Kuma Ref. 305 Color**standard**_NL Negro liso



KUMA_305

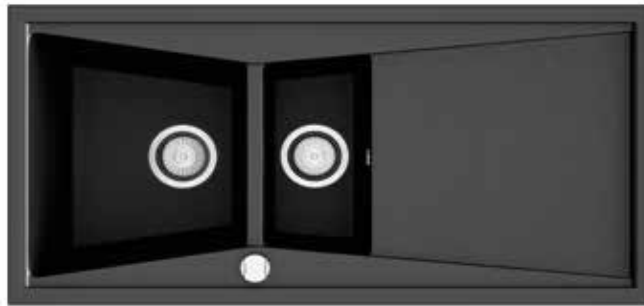

Kuma Ref. 305 Color **standard**_NL Negro liso

The industrial and urban esthetic acquires sense thanks to Kuma. This kitchen model emerges as one of the most used tendencies for the most modern and avant-garde style houses. The depurated design and the minimalist atmosphere that can be found in great cities inspire the Kuma collection.

COMPAC
THE SURFACES COMPANY

Portoro

NL Negro liso soft





KUMA_306



Kuma Ref. 306 Color**standard**_AL_Albero

L'avant-gardisme acquiert tout son sens dans les lignes des évier Kuma. Cette collection s'inspire des tendances actuelles et à venir pour être en harmonie la plus totale avec les maisons les plus modernes. Son design exclusif et ses formes inattendues font des évier Kuma une collection des plus atypiques.

KUMA_304



Kuma Ref. 304 Color **standard**_PG_Pergamón







Nuevas válvula ocultas opcionales de acero inoxidable_ New optional stainless steel concealed valves_ Nouvelles vannes occultes optionnelles en acier inoxydable.



KUMA_303

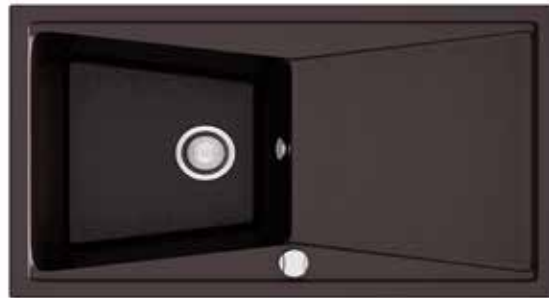

Kuma Ref. 303 Color**standard**_BR_Brown

KUMA_302



Kuma Ref. 302 Color **standard**_BL_Blanco.



KUMA_ Ref. 301



Profundidad cubeta 220 mm.
Bucket depth 220 mm.
Profondeur du godet 220 mm.

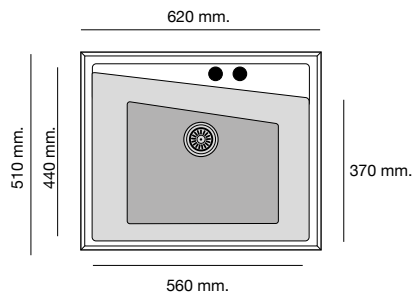

Roc_Stone®
Antibacteriano
Sobre encimera
Antibacterial
Inset
Antibactérien
À encastrer

KUMA_ Ref. 302



Profundidad cubeta 220 mm.
Bucket depth 220 mm.
Profondeur du godet 220 mm.

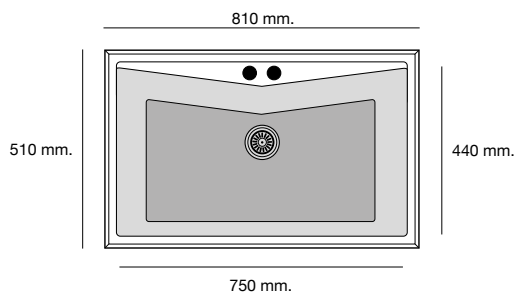

Roc_Stone®
Antibacteriano
Sobre encimera
Antibacterial
Inset
Antibactérien
À encastrer

KUMA_ Ref. 303



Profundidad cubeta 220 mm.
Bucket depth 220 mm.
Profondeur du godet 220 mm.

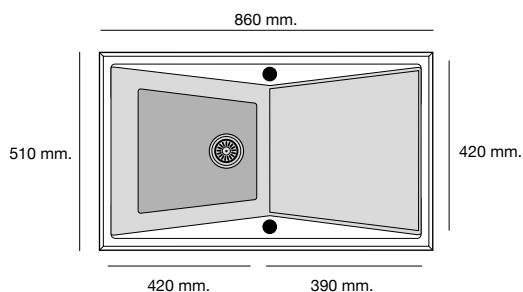

Roc_Stone®
Antibacteriano
Sobre encimera
Colocación reversible
Antibacterial
Inset
Reversible placement.
Antibactérien
À encastrer
Installation réversible

KUMA_ Ref. 304



Profundidad cubeta 220 mm.
Bucket depth 220 mm.
Profondeur du godet 220 mm.

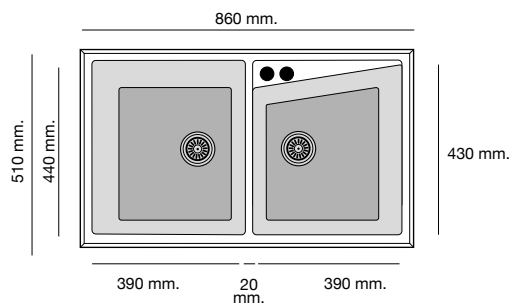

Roc_Stone®
Antibacteriano
Sobre encimera
Antibacterial
Inset
Antibactérien
À encastrer

La colección KUMA incluye garras de anclaje, válvulas automáticas extraplanas con maneta redonda, sifón y sellante.
 The KUMA collection includes anchor bar, ultra flat automatic valves with round handle, siphon and sealant.
 La collection KUMA comprend la barre de soutien, les vannes automatiques extra plat avec poignée ronde, le siphon et le colle mastic.

KUMA_Ref. 305

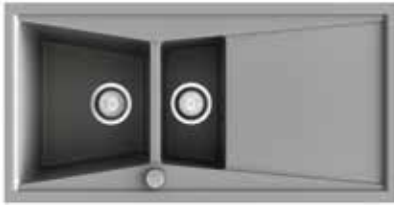

Profundidad cubeta 220 mm.
 Bucket depth 220 mm.
 Profondeur du godet 220 mm.

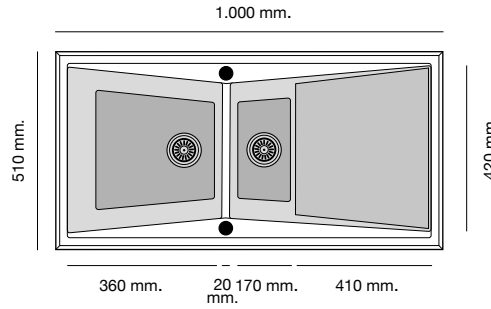

Roc_Stone®
 Antibacteriano
 Sobre encimera
 Colocación reversible
 Antibacterial
 Inset
 Reversible placement.
 Antibactérien
 À encastre
 Installation réversible

KUMA_Ref. 306



Profundidad cubeta 220 mm.
 Bucket depth 220 mm.
 Profondeur du godet 220 mm.

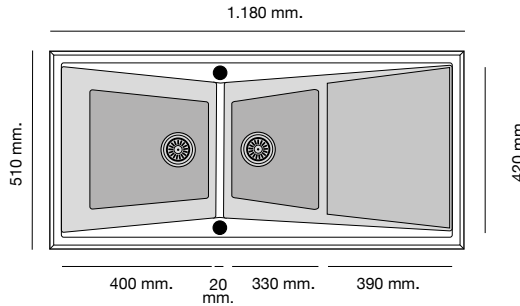

Roc_Stone®
 Antibacteriano
 Sobre encimera
 Colocación reversible
 Antibacterial
 Inset
 Reversible placement.
 Antibactérien
 À encastre
 Installation réversible

Accesorios_ accessories_accessoires

Válvula oculta_Concealed valve_Vanne occulte
 Opcional_optional_en option.
 Sencilla_Simple_Simple Ref_670_MER_SM
 Doble_Double_Double Ref_675_MER_SM



Acero inoxidable
 stainless steel
 acier inoxydable

Al incorporar la válvula oculta, eliminamos la automática.
 Es imprescindible indicar en pedido dicho cambio.
 When incorporating the hidden valve, we eliminate the automatic valve.
 En incorporant la vanne cachée, remove automatique.
 Il est essentiel pour indiquer le changement.

Colorstandard

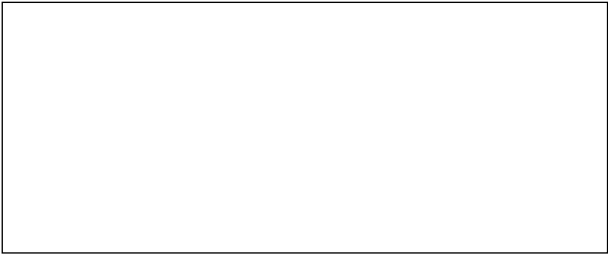

BL_BLANCO

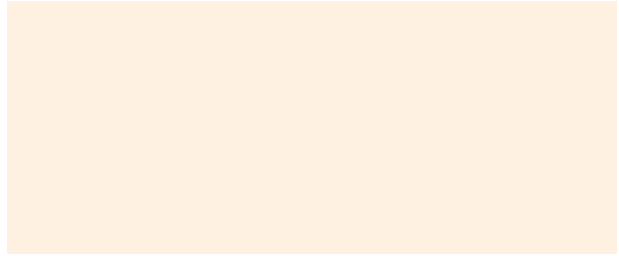

PG_PERGAMÓN

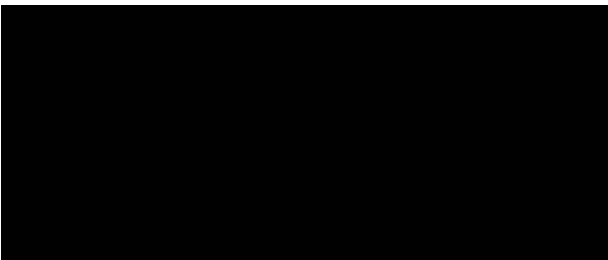

NL_NEGRO LISO



MT_METALIZADO



AL_ALBERO



CT_CONCRET



TU_TUNDRA

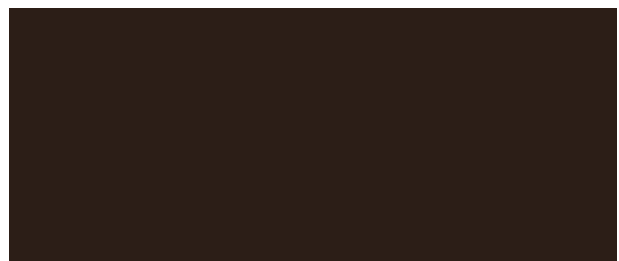

BR_BROWN

Pequeñas variaciones en los tonos de las piezas son una particularidad de los productos fabricados con cargas y pigmentos naturales y deben considerarse válidas.

Small variations in the tones of the pieces are a peculiarity of the products manufactured with mineral charges and natural pigments and they should be considered as valid.

Les petites variations dans les tons des pièces sont une particularité des produits fabriqués avec des charges minérales et des pigments naturels et ils doivent être considéré comme valide.

Colorstandard_Soft.

Nuevo acabado exclusivo para las colecciones ZIE y CITY.
New Finish exclusive for ZIE and CITY collection.
Nouvelle finition exclusif pour ZIE et CITY collections.

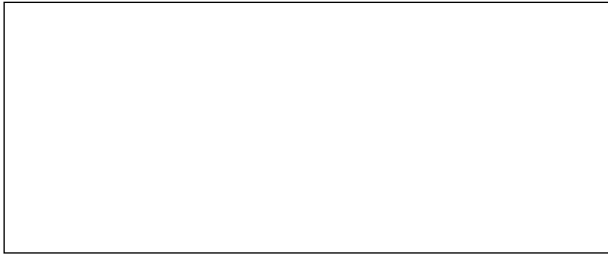

BL_BLANCO

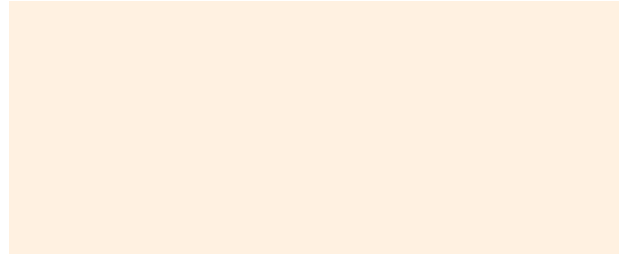

PG_PERGAMÓN

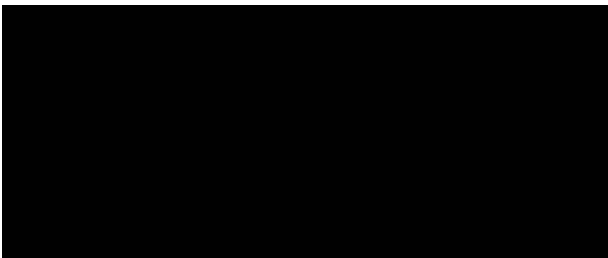

NL_NEGRO LISO



MT_METALIZADO



AL_ALBERO



CT_CONCRET



TU_TUNDRA

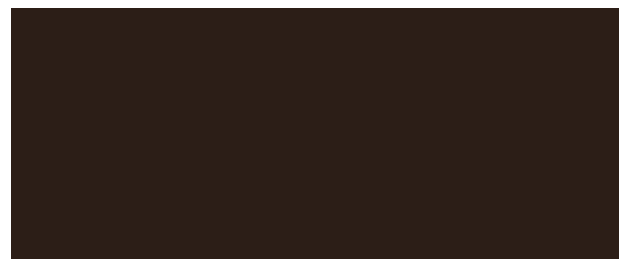

BR_BROWN

Colorplus

Con **Colorplus poalgi**, consigue adaptar el color de tu fregadero a partir del color de cualquier superficie (encimeras sintéticas, encimeras de madera, cerámica, porcelánicos, compactos) y/o gama de color tipo carta universal **RAL** o **NCS**
With **Colorplus system, poalgi** get fit the color of your sink, from the color of any surface (Synthetic countertop, wooden countertop, ceramic, porcelain, compact) and also, the color range as the universal system color **RAL** or **NCS**.
Avec **Colorplus, poalgi** réussit à adapter la couleur de votre évier à partir de la couleur de tout plan de travail (synthétiques, bois, céramiques, compactes) et/ou la gamme de couleur de type carte universel **RAL** ou **NCS**.

Uso y mantenimiento.

Use and maintenance Utilisation et d'entretien.



No se deben **utilizar** sustancias fuertemente alcalinas como el **amoniaco** o **sosa cáustica**, ni **productos industriales**, productos de limpieza que se hayan mezclado y **desinfectantes** que contengan **ácidos**. No verter **pinturas decorativas**, ni **tintes** u otras sustancias colorantes. En caso de hacerlo aclarar con abundante agua y seguir los pasos de mantenimiento y limpieza.

Strongly alkaline substances such as ammonia or caustic soda must not be used. Neither should industrial products, cleaning products that are mixed with disinfectant and that contain acids. Do not pour decorative paints, dyes or other colouring substances. In the event of this happening, rinse with vast amount of water and follow the maintenance and clearing instructions.

Eviter d'entrechoquer de substances fortement alcalines comme l'ammoniaque ou la soude caustique, de produits industriels, de produits de nettoyage mélangés et de désinfectants contenant dissolvants ou acides. Ne pas verser de peintures, de colorants, ou autres substances colorantes. Dans le cas contraire, rincer abondamment et suivre précisément les étapes concernant l'entretien et le nettoyage.



El **uso indebido** de las **alfombrillas** antideslizantes en el fregadero pueden ocasionar daños en las superficies. Si las dejamos durante largos periodos de tiempo se produce una constante retención de agua. A largo plazo puede producirse un efecto de tipo **bambollas** muy característico. **No descongelar productos** sobre la superficie del fregadero.

The inappropriate use of slip-resistant mats in the sink can damage the surface. If left for long periods of time, there is constant water retention, which over time creates a blister-type effect. Do not defrost products on the surface of the sink

L'utilisation incorrecte de tapis antidérapants dans l'évier peut en endommager les surfaces. S'ils ne sont pas retirés pendant de longues périodes, la rétention d'eau induite peut provoquer dans le temps l'apparition d'imperfections caractérisées. Ne pas décongeler de produits directement sur la surface de l'évier.



No usar estropajos de acero tipo "Nanas", utilizar esponjas, paños suaves o estropajos "no raya". **No tapar** u obturar el **rebosadero**.

Do not use strong scourers. Instead use sponges, cloths and soft scourers which will not scratch the surface. Do not cover or stopple the sink overflow.

Ne pas utiliser des produits d'entretien de type laine d'acier. Utiliser éponges, chiffons doux ou lavettes anti-rayures. Ne pas couvrir ou obturer le trop-plein.



No golpear con objetos, ni **usar** útiles **cortantes** y/o punzantes sobre el fregadero.

Do not hit or use sharp cutting objects on the surface.

Ne pas cogner l'évier avec des objets, ne pas utiliser d'outils coupants directement sur l'évier.



No colocar objetos recién **retirados del fuego**. No verter **aceites** o líquidos similares **hirviendo**.

Do not place objects that have been removed from the stovetop. Do not spill boiling oil or any other similar liquids.

Ne pas poser sur l'évier tout objet venant d'être retiré du four. Ne pas verser d'huile ou liquides similaires encore chaudes.

Limpieza diaria_Daily cleaning_ gouvernante.



Si con el paso del tiempo el fregadero acumula suciedad en el fondo o perduran las manchas, seguir las siguientes recomendaciones:

1. Dejar reposar durante **un par de horas** con agua y abundante **lejía**.
2. Aclarar con agua y **frotar con un cepillo** de púas vegetales o de plástico. En caso de que permanezcan las manchas, repetir la operación dejando reposar más horas y añadir más lejía.

Una limpieza diaria mantendrá su fregadero limpio durante toda su vida.

If over time the sink accumulates dirt in the bottom or if stains are not removed, follow the following recommendations:

1. Leave the sink soaking for two hours in water and a generous amount of bleach.
2. Rinse with water and rub with a vegetal or plastic spike brush. If the stains have not been removed, repeat the operation with more bleach and for a longer time.

Cleaning the sink once a day will keep your sink clean all its life.

Si dans le temps, une accumulation de salissure se dépose dans le fond de cuve ou des tâches perdurent, suivre les conseils suivants :

1. Remplir la cuve d'eau et d'eau de javel et laisser reposer pendant 2 heures.
2. Rincer à l'eau et frotter avec une brosse végétale ou plastique. Si les tâches persistent, répéter plus longuement l'opération de trempage et ajouter une quantité supérieure d'eau de javel.

Un nettoyage quotidien préservera l'évier dans un aspect optimal.



1

Usar una esponja con **jabón lavavajillas y agua**, aclarar con agua y secar con un trapo. Esta acción mantendrá su fregadero limpio durante toda su vida útil.

Use a sponge with dishwashing liquid and water, rinse with water and dry with a cloth. This action will keep your sink clean.

Utiliser une éponge avec du liquide vaisselle et de l'eau, rincer à l'eau et sécher avec un chiffon. Ainsi, l'aspect de l'évier restera optimal.



2



3



4

Limpieza diaria_Daily cleaning_gouvernante.



Manchas eventuales

Usar un trapo empapado con **lejía** y agua tibia. También es valido usar **disolventes universales** y posteriormente secar con un trapo. Según el tipo de mancha usaremos un disolvente de mayor o menor grado de pureza, como pueda ser la **acetona** y el **quitaesmalte**.

Occasional stains

Use a wet cloth with bleach and tepid water. You can also use universal solvents and dry with a cloth afterwards. Depending on the type of stain, we will use a more or less pure solvent, for example acetone or nail polish remover.

Eventuelles taches

En cas de taches, utiliser un chiffon imbibé d'eau de javel et d'eau chaude. Il est également possible d'utiliser un dissolvant universel, puis sécher avec un chiffon. Selon le type de tache, utiliser un dissolvant (acétone...) avec un niveau de pureté plus ou moins élevé.



Manchas de vino y/o café.

Se recomienda limpiar los líquidos muy penetrantes como el **café** o el **vino**, con un **bayeta** húmeda antes de que se sequen.

Wine and/or coffee stains

It is recommended to clean very penetrating liquids, such as coffee or wine, with a cleaning cloth before they dry.

Taches de café ou de vin

Nettoyer les liquides très pénétrants, comme le café ou le vin avec un chiffon avant séchage.



Manchas de cal

Para eliminarlas basta con aplicar **limón** o **vinagre disueltos en agua**.

Lime stains

To eliminate them, apply lemon or vinegar dissolved in water.

Taches de calcaire

Pour éliminer les taches de calcaire, appliquer du citron ou du vinaigre dissous dans l'eau.

Información técnica. Materiales

_Technical information. Materials_Information technique. Matériels.

Roc_Stone®

Fruto del esfuerzo en I+D+i **poalgi** | KITCHEN ha desarrollado un composite a base de resinas y un alto porcentaje en cargas minerales de alta resistencia y gran durabilidad que nos permite diseñar nuestros fregaderos sin limitaciones técnicas y con un gran acabado superficial.

Roc_Stone®

poalgi's I+R+D developed composite, with resins and high percentage of minerals a high resistance and durability that allows us to design our sinks without technical limitation and with a great superficial finishing.

Roc_Stone®

Fruit de notre département R&D **poalgi** a développé un composite à base de résines et de charges minérales en haute proportion, offrant une haute résistance et grande durabilité et permettant de concevoir des éviers sans limites techniques et avec une parfaite finition de Surface.

Bactiblock

Es un aditivo antimicrobiano idóneo para una amplia variedad de materiales poliméricos. La tecnología patentada por NBM está basada en arcilla funcionalizada con plata, comportándose como una fuente natural altamente eficaz como agente antimicrobiano. Este aditivo inhibe el crecimiento de bacterias hongos y levaduras, siendo por tanto una herramienta muy eficaz frente a olores y manchas.

Bactiblock

It's antimicrobial additive suitable for a wide range of polymeric materials. NBM's patented technology is based on functionalized clay silver, behaving as a highly effective natural source as an antimicrobial agent. The additive inhibits the growth of bacteria, fungus and yeast, making it a very effective against odor and stain tool.

Bactiblock

Ce procédé est un additif antimicrobien idéal pour une large variété de matériaux polymères. La technologie brevetée par la société NBM repose sur une argile fonctionnalisée avec de l'argent, laquelle va se comporter comme une source naturelle hautement efficace comme agent microbien. Cet additif inhibe le développement des bactéries de type champignon et levure, se convertissant ainsi en une solution efficace contre les odeurs et les tâches.



Datos técnicos_Technical data_Données techniques.

Resistencia al impacto_ Impact strength_ Résistance à l'impact	12 kgf/m2
Resistencia a la compresión_ Compression strength_ Résistance à la compression	1 595 kgf/m2
Resistencia a la flexión_ Flexion strength_ Résistance à la flexion	5 110 MPA
Resistencia térmica _ Technical thermal_ Résistance thermique	130 C°
Dureza barcol (935)_ Hardness barcol_ Dureté barcol	45

Resistencia al manchado_Stain resistance_Résistance aux taches.

Con ácido clorhídrico_ Whit hydrochloric acid_ avec acide chlorhydrique	Sin cambios_ Without changes_ Inchangé
Con detergentes_ Whit detergents_ avec détergeant	Sin cambios_ Without changes_ Inchangé
Con anticalcáreos_ Whit anti-scale_ avec anticacaires	Sin cambios_ Without changes_ Inchangé
Con amoníaco_ Whit ammonia_ avec ammoniac	Cambio moderado_ Moderate change_ changement modéré

Estudio técnico de calidad efectuado por_ Quality technical study carried out by_ Etude de la qualité technique réalisée par:

AIMPLAS – Instituto Tecnológico del Plástico_ Technological Institute of Plastic_ Institut des plastiques techniques
Informe_ Report_ rapport: AT-0819/13 de 29/07/2013.

Información comercial.

_Technical information_Information technique.

Garantía de calidad.

poalgi garantiza todos sus productos fabricados por el plazo de cinco años a partir de su fecha de compra, contra cualquier defecto de fabricación siempre que el producto se destine a usos domésticos.

Esta garantía no incluye desperfectos o roturas a consecuencia de transportes, así como tampoco los derivados de la instalación incorrecta, ni los accesorios que lo acompañan.

La manipulación en el nº de serie o en los datos de este certificado, anula la presente garantía.

Los términos de garantía serán aplicables cuando la instalación sea la correcta y el uso y mantenimiento sean los adecuados, considerándose:

1. La instalación del fregadero debe realizarse tal y como se detalla en el Manual de instalación suministrado, en caso contrario la instalación no será susceptible de garantía.
2. Como consecuencia de una instalación incorrecta o una manipulación indebida del fregadero, **poalgi** no cubrirá los gastos de manipulación.
3. El uso y mantenimiento del fregadero debe realizarse tal y como se detalla en el Manual de uso y mantenimiento suministrado, en caso contrario no será susceptible de garantía.
4. Quedan excluidos de la garantía los accesorios (válvulas, tablas de corte...etc.)
5. **poalgi** se encargará de reparar o reemplazar el fregadero a través del establecimiento en el que fue adquirido el fregadero (nunca el reembolso económico). El cliente deberá aportar los datos del fregadero e incluso fotografías de calidad para que nuestro departamento técnico pueda comprobar y determinar que el producto se encuentra cubierto por la garantía.

No se admiten cambios ni devoluciones.



Esta edición anula las anteriores
This edition cancels the previous ones
Cette édition annule la précédente

Quality guarantee

poalgi guarantees all its manufactured products for the term of five years from its date of purchase, against any defect of manufacture provided that the product is destined to domestic uses.

This warranty does not include damages or breakages as a result of transport, nor the derivatives of improper installation, nor the accessories that accompany it.

Handling in the serial number or in the data of this certificate, voids this warranty.

The warranty terms will apply when the installation is correct and the use and maintenance are adequate, considering:

1. The installation of the sink must be done as detailed in the Installation Manual supplied, otherwise the installation will not be subject to warranty.
2. As a result of improper installation or improper handling of the sink, **poalgi** will not cover handling costs.
3. The use and maintenance of the sink must be carried out as detailed in the Operating and Maintenance Manual supplied, otherwise it will not be subject to guarantee.
4. The accessories (valves, cutting boards ... etc) are excluded from the guarantee.
5. **poalgi** will repair or replace the sink through the establishment where the sink was purchased (never the economic refund). The customer must provide the sink data and even quality photographs so that our technical department can verify and determine that the product is covered by the guarantee.

No changes or refunds allowed.

L'assurance qualité

poalgi garantit tous les produits qu'elle fabrique pour une durée de 5 ans à partir de la date d'achat, contre tout défaut de fabrication et à la condition que le produit soit destiné à un usage domestique.

























Cette garantie ne couvre pas les dommages ou casses causés par les transports, ainsi que les conséquences d'une installation incorrecte, mais également les accessoires. Une modification du n° de série ou des dates de certificat annule la présente garantie.

Les termes de la garantie seront applicables si l'installation est correcte et que l'utilisation et l'entretien sont adaptés en considérant les points suivants :





















1. L'installation de l'évier doit se faire comme indiqué dans le manuel d'installation fournie; dans le cas contraire, l'installation ne sera pas soumise à garantie.
2. En conséquence d'une installation incorrecte ou d'une manipulation malencontreuse de l'évier, **poalgi** ne couvrira pas les coûts de manipulation.
3. L'utilisation et l'entretien de l'évier doit se faire comme indiqué dans le manuel d'utilisation et d'entretien fourni ; dans le cas contraire, la garantie ne pourra s'appliquer.
4. Sont exclus de la garantie les accessoires (bondes, planches à découper, ...)
5. **poalgi** se chargera de réparer ou de remplacer l'évier par le biais de l'établissement vendeur (aucun avoir ne sera réalisé). Le client devra apporter les informations relatives à l'évier et même les photos de qualité pour que notre département technique puisse vérifier et déterminer que le produit est bien couvert par la garantie.

Aucun échange ni remboursement ne seront acceptés

Clasificación por mueble _Furniture Classification_Mobilier de classification.

45 cm.	50 cm.	60 cm.	70 cm.
 Ref.121 BASIC *	 Ref.303 KUMA	 Ref.301 KUMA	
 Ref.152 BASIC (sobre encimera) *	 Ref.116 BASIC	 Ref.152 BASIC (bajo encimera) *	 Ref.305 KUMA
	 Ref.501 SHIRA (bajo encimera)	 Ref.106 BASIC *	 Ref.113 BASIC *
 Ref.104 BASIC *		 Ref.105 BASIC *	 Ref.502 SHIRA (sobre y bajo encimera)
 Ref.501 SHIRA (sobre encimera)		 Ref.503 SHIRA (sobre encimera)	 Ref.172 ZIE
	 Ref.163 GANDIA	 Ref.171 ZIE (bajo encimera)	 Ref.321 CITY
 Ref.162 GANDIA		 Ref.164 GANDIA	 Ref.165 GANDIA
		 Ref.507 SHIRA (sobre encimera)	
		 Ref.320 CITY	

* Las imágenes y características de los modelos de la colección BASIC, están especificados en a tarifa **poalgi** Kitchen.
 The pictures and characteristics of the models of the BASIC collection, are specified in the **poalgi** Kitchen prices.
 Les images et les caractéristiques des modèles BASIC collection sont spécifiés dans le tarif de **poalgi** Kitchen.

80 cm.	90 cm.	90X90 cm.	100 cm.
 Ref.302 KUMA		 *	 *
 Ref.306 KUMA		 *	 Ref.505 SHIRA
 *	 Ref.304 KUMA		
 *	 Ref.503 SHIRA (bajo encimera)		
 *	 Ref.504 SHIRA (bajo y sobre encimera)		
 *	 Ref.506 SHIRA (bajo encimera)		
 Ref.173 ZIE	 Ref.323 CITY		
 Ref.174 ZIE			
 Ref.506 SHIRA (sobre encimera)	 Ref.507 SHIRA (bajo encimera)		
 *			
 Ref.322 CITY			

Créditos _Credits_Crédits.

Agradecimientos _Thanks_Remerciements

Desde **poalgi** queremos agradecer a todos los profesionales y proveedores que han participado en la producción de este catálogo, todo su esfuerzo y dedicación. Muchas gracias.

From **poalgi** we want to thank all the professionals and suppliers who have participated in the production of this catalog, all their effort and dedication. thank you very much.

De **poalgi** nous tenons à remercier tous professionnels et fournisseurs qui ont participé à la production de ce catalogue, tous leurs efforts et leur dévouement. Merci beaucoup.

Dirección y gestión del diseño

Design management
Design management

Javier Pastor Castillo

(IGD Instituto para la investigación y gestión del diseño Universitat Politècnica de València).

Texto

Text
Texte

poalgi departamento de diseño y comunicación.

Traducción

Translation
Traduction

poalgi departamento de diseño y comunicación.

Dirección y desarrollo de productos

Product design and development
Conception et développement de produits

poalgi departamento de diseño y comunicación.